

PNEUMATIC SWITCHES - DW

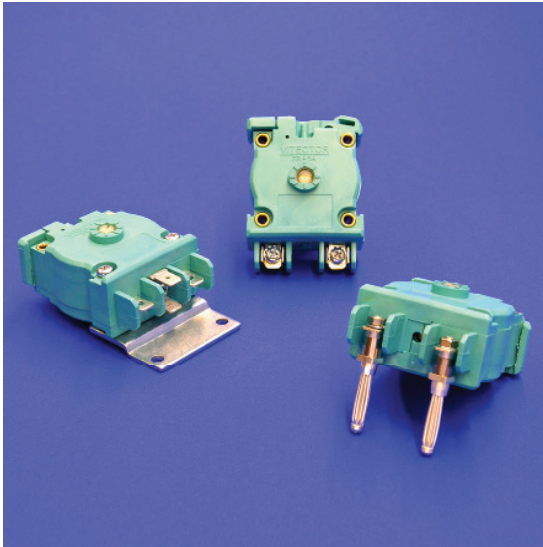

Kinds of contacts:

S = Normally open contact

O = Normally closed contact

W = Change over contact

Pneumatic switches - DW

Designation	ID-No.	Remark
DW 2S-100	10005733	Round connector plugs 90°, NOC
DW 2O-100	10005859	Round connector plugs 90°, NCC
DW 3S-100	10005652	Screw type connectors, NOC
DW 3S-200	10005688	Screw type connectors, NOC, in medium-sized enclosure
DW 3S-300	10008797	Screw type connectors, NOC, in big enclosure
DW 3O-100	10005713	Screw type connectors, NCC
DW 3O-200	10005687	Screw type connectors, NCC, in medium-sized enclosure
DW 3O-300	10007432	Screw type connectors, NCC, in big enclosure
DW 3O-306	10007379	NCC on PCB, large housing, 2 x stop circuit
DW 3W-420	10005797	Screw type connectors, NOC/NCC changeover contact, galvanized steel mounting flange
DW 3W-220	10005795	Screw type connectors, NOC/NCC changeover contact, in medium-sized enclosure
DW 5S-100	10005856	6.3 mm flat connector type, NOC
DW 5O-100	10005857	6.3 mm flat connector type, NCC
mounting kit *	10005918	Small mounting angle and 2 pieces M3x25 screws

* = this part is equipped as standard by the DW-3W 420

PNEUMATIC SWITCHES - DW

Technical data

General data	
Diaphragm material	0.3 mm EPDM (-30 °C to +150 °C)
Weight	55 g
Dimensions	55 mm x 45 mm x 33 mm
Contact loads	220 V, 0.5 A
Number of operations	max. 10/sec
Response sensitivity	0.2 to 50 mbar
Standard setting	3 mbar
Mechanical resistance	200 mbar
Ventilation screw	Factory preset open, tighter setting available on request
Types of Housing	21 D 12 plastics grey, other types on request

Mounting Possibilities

After the redesign of the airwave switch housing, there are different ways of mounting the switch to the position needed. By Ø 4 mm hollow rivets the housing of the airwave switch, that is leveled on one side (not for changeover-contact), can be mounted by M3 screws directly on to a mounting plate.

The pitch of the Ø 3.3 connection holes is the same as on the old airwave switch series. Thereby all mounting angles, developed for the old switch, can still be used for the new switch.

Additionally the new housing offers the possibility of mounting it to a DIN rail.

Connectors

The electrical connectors of the airwave switch have changed to 6.3 mm flat connectors. Additionally versions with screw type terminals and round plugs are available.

PNEUMATIC SWITCHES - DW

Drawings

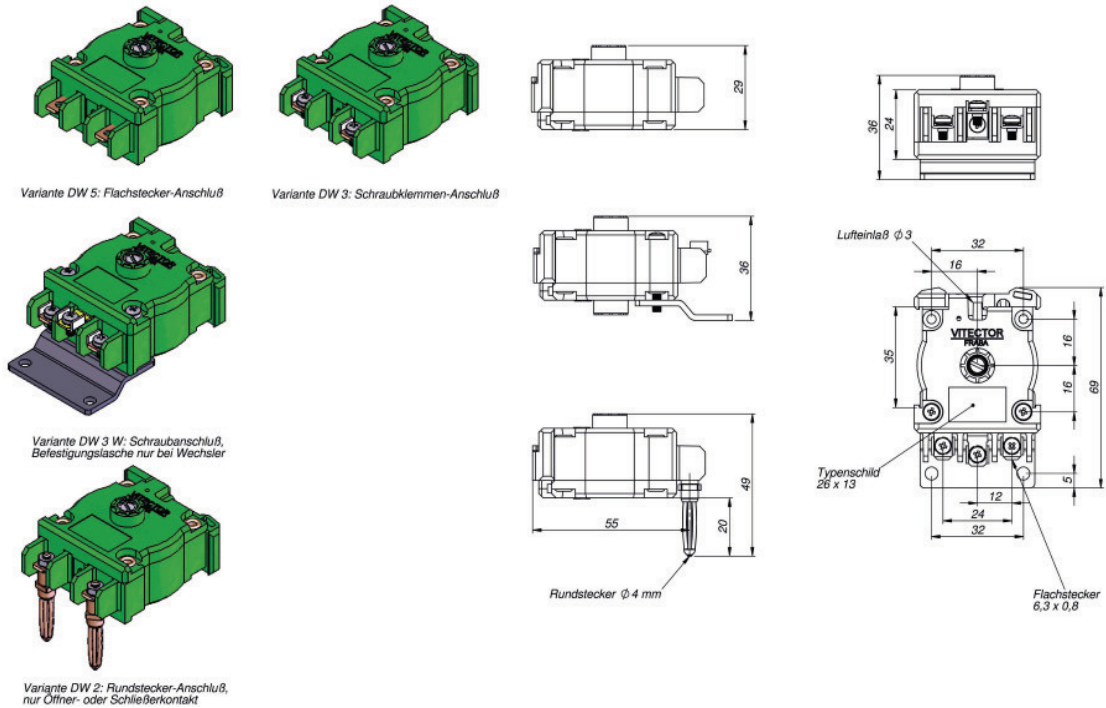

Dimension IP65 housings

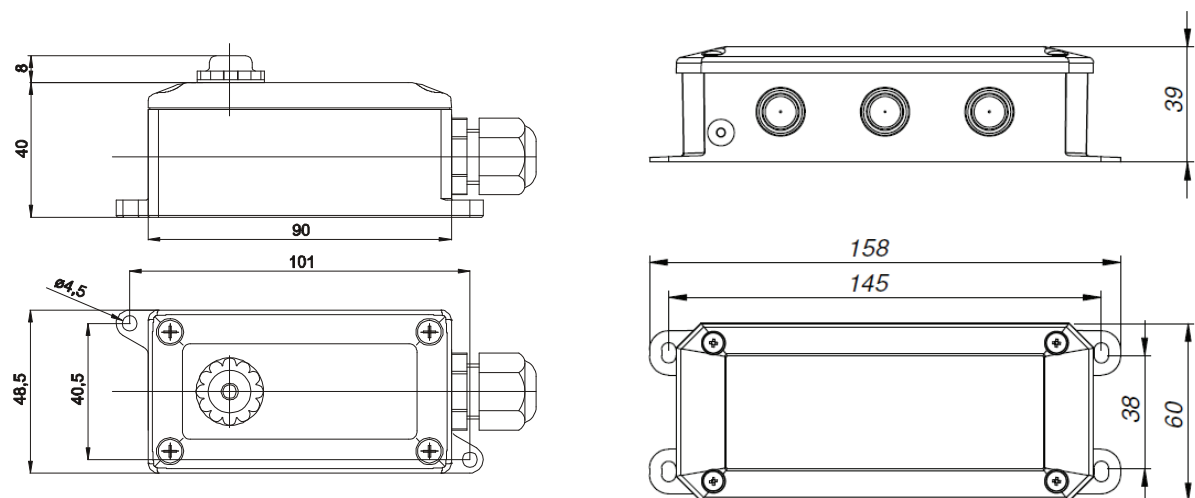

Housing IP65, Type: 200

Housing IP65, Type: 300

DW 30-306

DW with connection PCB

The DW 30-306 NCC is mounted on a PCB in the large junction box JB 3000. The PCB provides connection capability for a 4-pole spiral cable, slack-cable and wicket-door-switch. M12 and M16 cable glands can be inserted in the pre-punched housing entries as necessary.

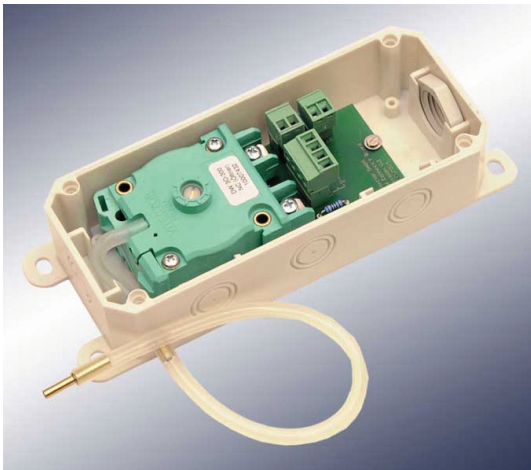

Compatibility

The PCB is designed to be connected to a 1k2-interface. If the control board requires an 8k2-interface the PCB has to be modified. Modification can be done on site and does not require special tooling nor knowledge.

Spiral cable connection

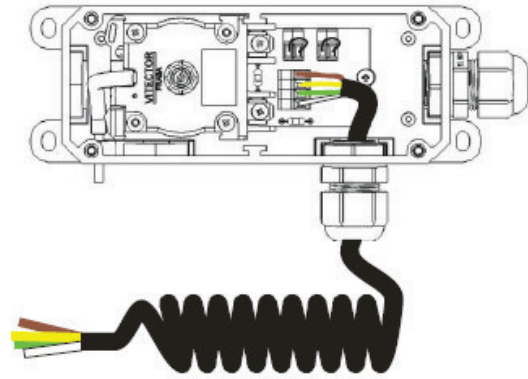

Terminal	Color	Function
1.1	White	DW
1.2	Green	DW
1.2	Yellow	Stop
1.4	Brown	Stop

PNEUMATIC SWITCHES - DW

Adjustment diagrams

The first figure shows the influence of the contact gap on the response sensitivity. The range, over which the sensitivity was measured, covers typical values for DW switches.

The lower figure shows the influence of the ventilation on the response sensitivity, measured with a position of the adjusting screw to 4 divisions.

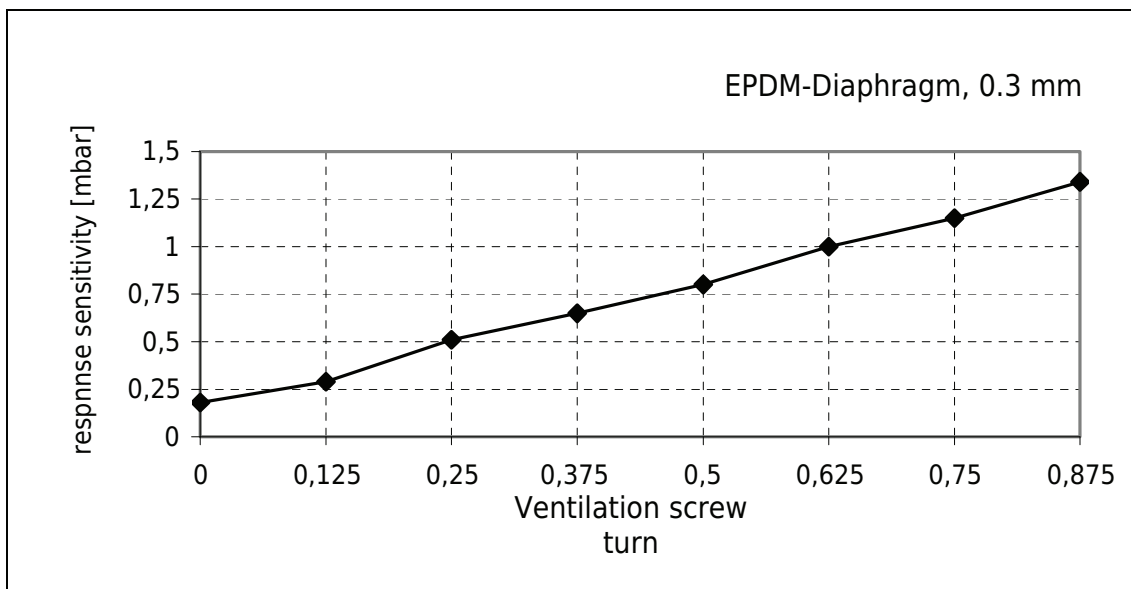
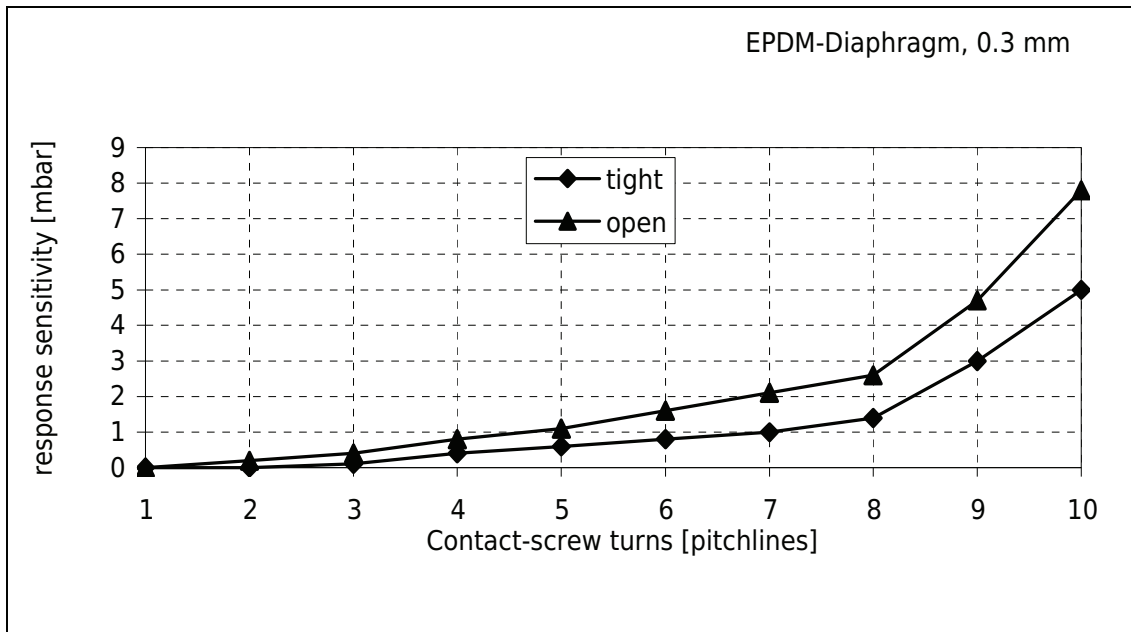

Contact



CEDES AG
sales@cedes.com