

Optical Sensing Edge (with status LED)

OSE-S 6xxx

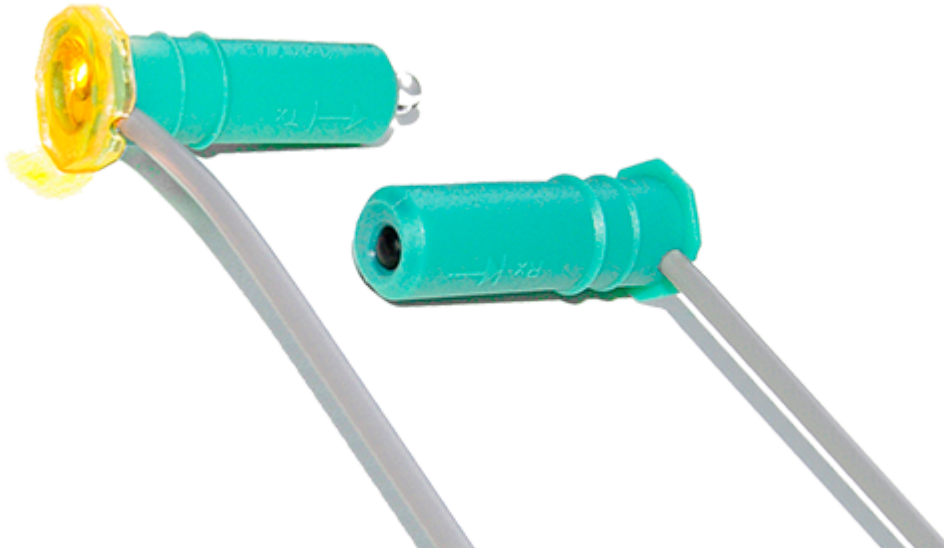

General Data



Interface	3 wire OSE
Technology	Optical contact edge with status LED
Transmitter cable length*	0.5 m (1.6 ft) / 6.5 m (21.3 ft) / 8.5 m (27.9 ft) / 10.5 m (34.5 ft)
Receiver cable length*	0.5 m (1.6 ft) / 1.0 m (3.3 ft) / 3.0 m (9.8 ft) / 4.5 m (14.8 ft) / 10.5 m (34.5 ft)
Supply voltage	4 ... 28 VDC
Safety properties	Cat. 3 PL d (EN ISO 13849-1)
MTTFd	100 years
DCav	90%
PFHd	$4.6 \cdot 10^{-8} / h$
Maximum operation period	20 years
Housing dimensions W x H x D	37 mm x 11 mm (1.46" x 0.43")
Operation temperature	-20 °C to +75 °C (-4 °F to +167 °F)
Protection class	IP68
Cable layout	PVC / PVC, tinned ends
Version	V6 (suitable for battery systems)
Diameter	11 mm (0.43 ")
Weight	0.03 kg
Range	0.5 m ... 10 m (1.6 ft ... 32.8 ft)
Sealing compound	Polyurethane (Emitter: Grey, receiver: Black)
Housing material	Polyethylene

* The cable lengths depend on the OSE types

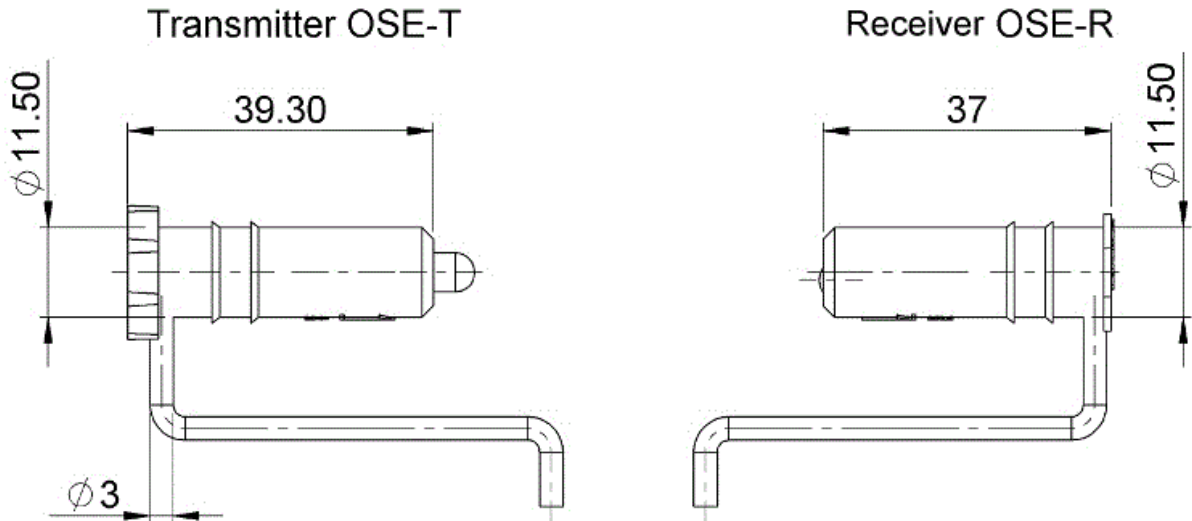
Unit of measure	Piece
Product life cycle	Established



Compatible controllers

	Product	Supply voltage	Input type of sensing edge
	OSE-C 2324	24 VAC/DC	3-wire
	OSE-C 2300	230 VAC	3-wire
	OSE-C 2301	24 VDC	3-wire



OSE-C 2323 230 VAC 3-wire



OSE-C 1001 24 VAC/DC 3-wire

Compatible Junction Boxes



Product connection options	Housing
JB 1307 PCB with screw-terminals	Small (75x40x13 mm / 2.95x1.57x0.51")



JB 2106 terminal strip	Medium (90x48.5x40 mm / 3.54x1.91x1.57")
------------------------	--

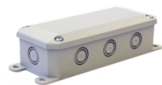

JB 3000 terminal strip	Large (158x60x39 mm / 6.22x2.36x1.54")
------------------------	--



JB 4400 PCB with OSE plugs or screw-terminals	Large (158x60x39 mm / 6.22x2.36x1.54")
---	--



JB 5610 PCB with OSE plugs	Medium (90x48.5x40 mm / 3.54x1.91x1.57")
----------------------------	--

Compatible Rubber Profiles



Product	Height	Width
OSE-P 14 36 04	36 mm (1.42")	14 mm (0.55")







OSE-P 45 60 04	60 mm (2.36")	45 mm (1.77")
----------------	---------------	---------------



OSE-P 20 40 01	40 mm (1.57")	20 mm (0.79")
----------------	---------------	---------------



OSE-P 25 90 00	90 mm (3.54")	25 mm (0.98")
----------------	---------------	---------------

	OSE-P 25 75 01	75 mm (2.95")	25 mm (0.98")
	OSE-P 25 75 00	75 mm (2.95")	25 mm (0.98")
	OSE-P 14 36 00	36 mm (1.42")	14 mm (0.55")
	OSE-P 15 40 00	40 mm (1.57")	15 mm (0.59")
	OSE-P 45 60 00	60 mm (2.36")	45 mm (1.77")

Contact



CEDES AG
sales@cedes.com

All dimension in [inch] mm. This drawing and the information contained is for general presentation purposes only. Please refer to the "Download" section for detailed technical drawings. © CEDES AG., All rights reserved. We do not assume responsibility for technical inaccuracies or omissions. Specifications are subject to change without notice.