

ELKA SLIDE GATE OPENERS

230V / 400V



HIGH QUALITY AND
TESTED SECURITY



COMFORTABLE OPERATION
AND EASY INSTALLATION



ROBUST, DURABLE
AND RELIABLE

ELKA

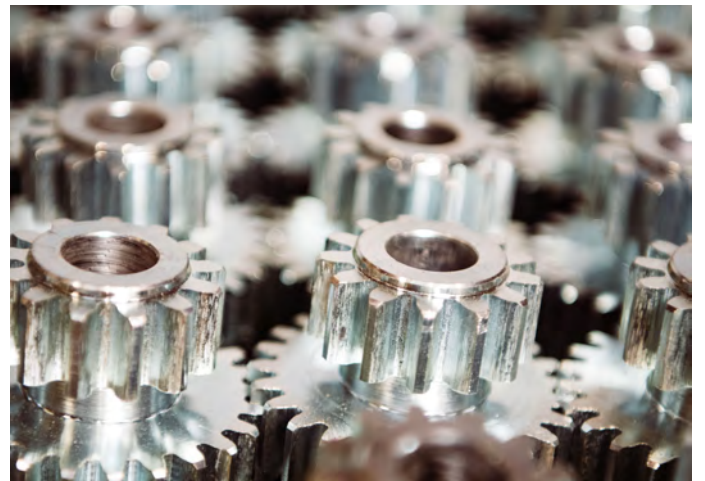
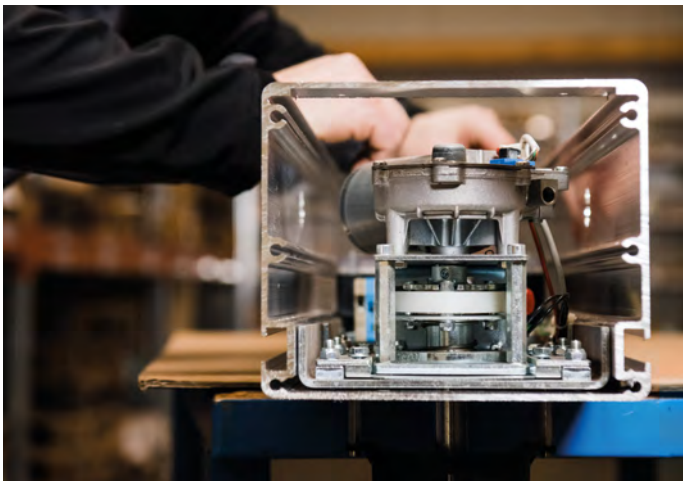

TABLE OF CONTENTS

<u>Slide gate openers 230V - in a compact housing</u>	<u>Page 06 - 07</u>
<u>Slide gate openers 230V - in a convenient housing</u>	<u>Page 08 - 09</u>
<u>Slide gate openers 400V - in a convenient housing</u>	<u>Page 10 - 11</u>
<u>Controller MO 44-2</u>	<u>Page 12 - 13</u>
<u>Accessories</u>	<u>Page 14 - 17</u>
<u>Technical data</u>	<u>Page 18 - 21</u>
<u>ELKA Torantriebe - Partner with competence</u>	<u>Page 22 - 30</u>



ELKA Slide gate openers

ELKA offers a selection of slide gate openers in a compact housing for gates up to 16,000mm and 2,000kg or in a convenient housing for gates up to 20,000mm and 4,000kg. All gate openers are height adjustable up to 30mm.

The safety contact profile detection can be used for OPEN and CLOSE separately. For compliance with safety regulations, ELKA optionally supplies the suitable safety contact profiles and photoelectric barriers.



The compact housing is made of robust steel. The components are easily accessible by loosening two screws on the sides of the gate opener. After the screws are loosened, the cover can be easily removed.

The convenient housing made of aluminium offers plenty of space for additional installations. The components are easily accessible via service door. Unlocking is done by using a hexagon key, which releases the clamping mechanism.

For serial gates designed in accordance with the EU-norms, ELKA offers support during the certification process.

230V in a compact housing

for gates up to 16,000mm and 2,000kg



230V in a compact housing

for gates up to 16,000mm and 2,000kg

EST 1204 for gates up to 1,200kg and 12,000mm

EST 2004 for gates up to 2,000kg and 16,000mm

Quality

The housings are made of steel and are galvanized and powder coated afterwards.

Safety

Immediate stop via electronic brake and reversing for a short distance take place when a safety device is activated. For compliance with the safety regulations ELKA supplies the suitable safety contact profiles and photoelectric barriers.

For serial gates designed in accordance with the EU-norms, ELKA offers support during the certification process. The perfect opportunity for gate manufacturers to offer a certified system.

Variable

All gate openers of this series are height adjustable up to 30mm.

Toothed wheels and toothed racks

Standard:

Toothed rack, zinc coated, module 4, height adjustable, incl. spacers to be screwed on the gate.

Toothed wheel, zinc coated, module 4.

Alternatively:

Toothed rack, zinc coated, module 6, to be welded on the gate.

Toothed wheel, zinc coated, module 6.

230V in a convenient housing

for gates up to 16,000mm and 2,000kg



230V in a convenient housing

for gates up to 16,000mm and 2,000kg

EST 1204K for gates up to 1,200kg and 12,000mm

EST 2004K for gates up to 2,000kg and 16,000mm

Quality

The housings are made of powder-coated aluminium and offer plenty of space for additional installations. Including maintenance power outlet and completely pre-wired terminal row and socket for a 1-channel loop detector.

Safety

Immediate stop via electronic brake and reversing for a short distance take place when a safety device is activated. For compliance with the safety regulations ELKA supplies the suitable safety contact profiles and photoelectric barriers.

For serial gates designed in accordance with the EU-norms, ELKA offers support during the certification process. The perfect opportunity for gate manufacturers to offer a certified system.

Variable

All gate openers of this series are height adjustable up to 30mm.

Toothed wheels and toothed racks

Standard:

Toothed rack, zinc coated, module 4, height adjustable, incl. spacers to be screwed on the gate.

Toothed wheel, zinc coated, module 4.

Alternatively:

Toothed rack, zinc coated, module 6, to be welded on the gate.

Toothed wheel, zinc coated, module 6.

400V in a convenient housing

for gates up to 20,000mm and 4,000kg



400V in a convenient housing

for gates up to 20,000mm and 4,000kg

EST 2204K for gates up to 2,200kg and 18,000mm

EST 4004K for gates up to 4,000kg and 20,000mm

Quality

The housings are made of powder-coated aluminium and offer plenty of space for additional installations. Including maintenance power outlet and completely pre-wired terminal row and socket for a 1-channel loop detector.

Safety

Immediate stop via electronic brake and reversing for a short distance take place when a safety device is activated. For compliance with the safety regulations ELKA supplies the suitable safety contact profiles and photoelectric barriers.

For serial gates designed in accordance with the EU-norms, ELKA offers support during the certification process. The perfect opportunity for gate manufacturers to offer a certified system.

Variable

All gate openers of this series are height adjustable up to 30mm.

Toothed wheels and toothed racks

Standard for EST 2204K:

Toothed rack, zinc coated, module 4, height adjustable, incl. spacers to be screwed on the gate.

Toothed wheel, zinc coated, module 4.

Alternatively for EST 2204K:

Toothed rack, zinc coated, module 6, to be welded on the gate.

Toothed wheel, zinc coated, module 6.

Standard for EST 4004K:

Toothed rack, zinc coated, module 6, to be welded on the gate.

Toothed wheel, zinc coated, module 6.

Controller MO 44-2

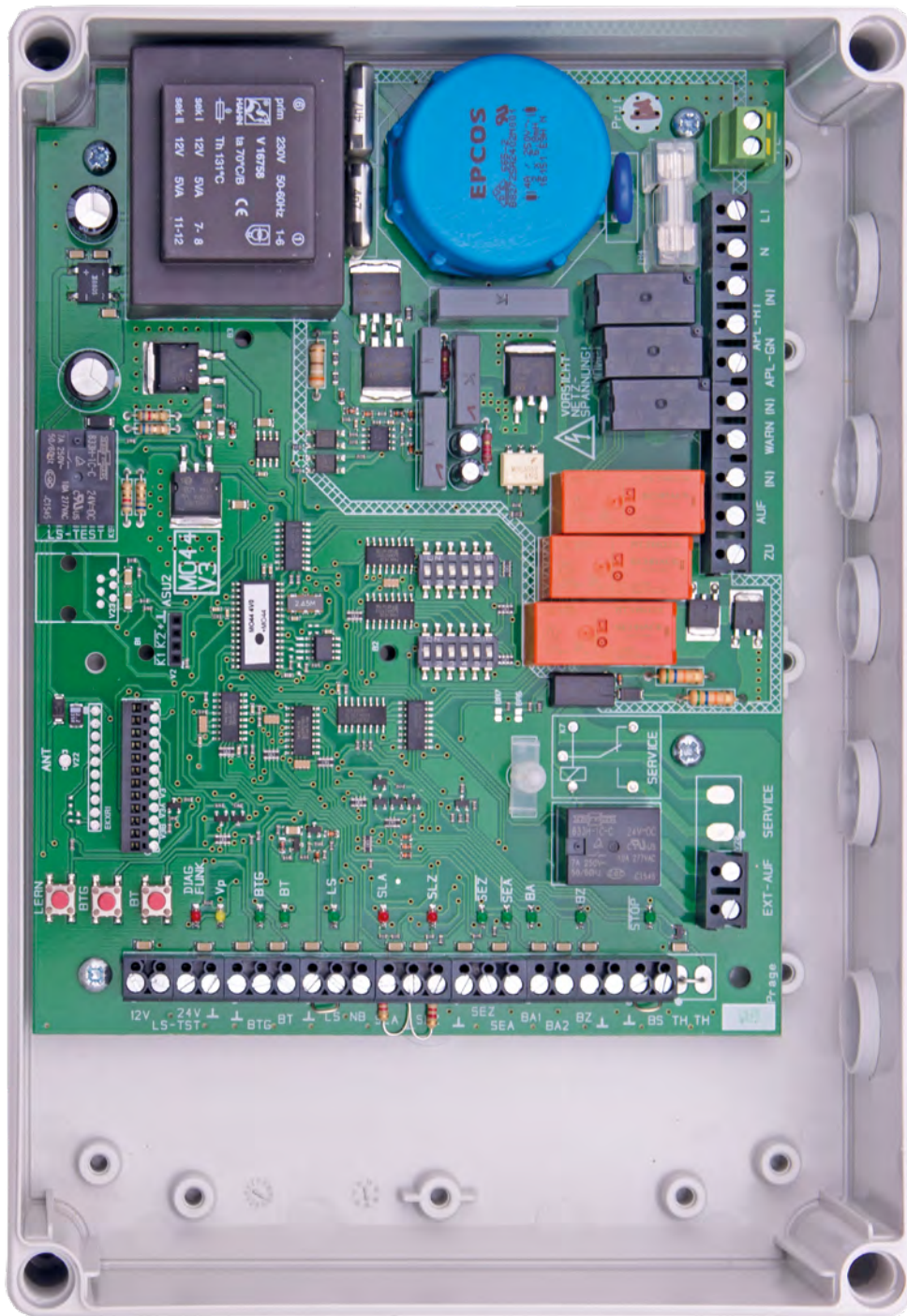

Professional

- ✓ One button input with serial switching or three button input
- ✓ Safety contact profile detection for OPEN and CLOSE separately, 8.2kOhm
- ✓ Running distance limitation by magnetic limit switches
- ✓ Power supply 230V/50Hz
- ✓ Redundant stop contact
- ✓ Tandem operation
- ✓ LED-display for motor voltage, safety contacts profiles, photoelectric barriers and command inputs

Comfortable

- ✓ Partial opening learnable (via radio remote control or switch)
- ✓ Automatic closure for complete and partial opening separately adjustable (0-300s)
- ✓ Socket for optional radio remote control receiver
- ✓ Socket for optional 7-day-timer module
- ✓ Traffic light connection, potential free, max. 230V/60W, with sleepmode
- ✓ Warning light connection, potential free, max. 230V/60W
- ✓ Connection for up to 6 photoelectric barriers with testing function
- ✓ Day/night-operation selectable

Safety

- ✓ Pre-warning time 4s prior to opening and closing separately selectable
- ✓ Emergency mode via button on the controller in case of failure of a safety device (after approx. 10s dead man's mode)
- ✓ Dead man's mode selectable

Toothed wheels



Module 4, galvanized steel

For ELKA slide gate openers 230V and EST 2204K (400V).



Module 6, galvanized steel

For ELKA slide gate openers 230V and EST 2204K (400V).



Module 6, galvanized steel

For ELKA slide gate openers EST 4004K (400V).

Toothed racks



Module 4, galvanized steel, 30x12mm

Height adjustable, to be screwed on the gate.

For ELKA slide gate openers 230V and EST 2204K (400V).



Module 6, galvanized steel, 30x30mm

To be welded on the gate.

For ELKA slide gate openers 230V and 400V.

Safety contact profiles

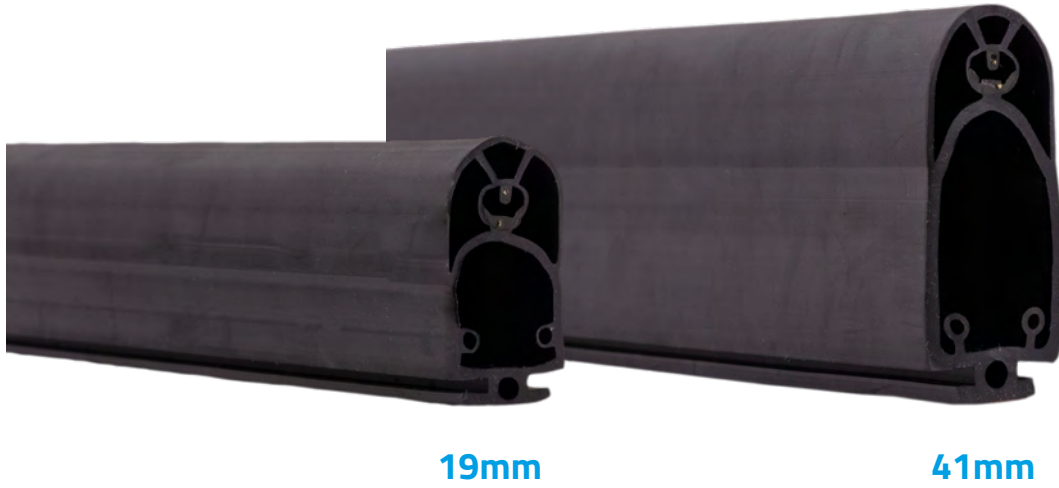

HS-system

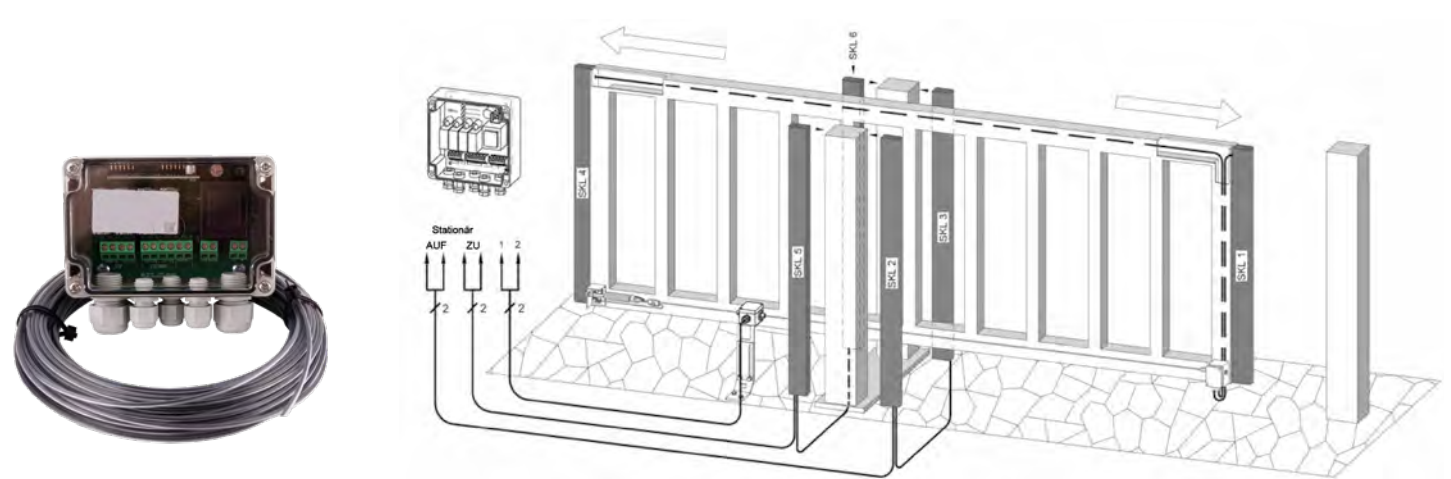

Current-carrying system, inductive, for safety contact profiles at the main closing edge of slide gates up to 20,000mm length.

Photoelectric barriers



Photoelectric barrier, flush mounting

10 - 40Vdc, 10 - 30Vac, 18m range



Photoelectric barrier, surface mounting

12 - 24Vdc/ac, 18m range

Lights



LED flashing light, yellow

230V or 24Vdc/ac



Round flashing light, orange

230V



LED traffic light, red or green

24V or 230V, 250 or 600-850 lumen

Access control devices



Key switch

surface or flush mounting



Code switch

with stainless steel keypad

Timer module



7-day-timer module

to be plugged onto the controller

Radio remote control



Radio remote control transmitters

434MHz / 868MHz, codeable, very good range

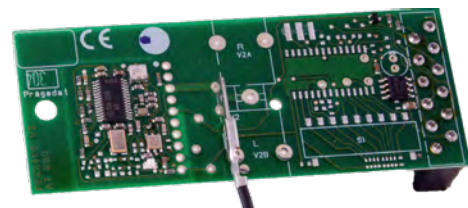

Receiver module

to be plugged onto the controller

Further accessories can be found in our price list.

Technical data 230V in a compact housing

230V gate opener	EST 1204	EST 2004
Max. gate weight	1,200kg	2,000kg
Max. gate length	12,000mm	16,000mm
Power supply	230V / 50Hz	
Motor voltage	230Vac	
Velocity max.	0.18m/s	
Self blocking when gate OPEN/CLOSED	yes	
Max. cycles per hour	14	10
Brake function	yes	
Limit switches	2 magnetic	
Maintenance power outlet	no	
Emergency release	yes	
Height adjustable	30mm	
Toothed wheel	Module 4, zinc coated (optionally module 6)	
Dimensions (WxHxL)	335x410x230mm	
Weight approx.	28.0kg	28.5kg
Controller	MO 44-2	

View from the front:

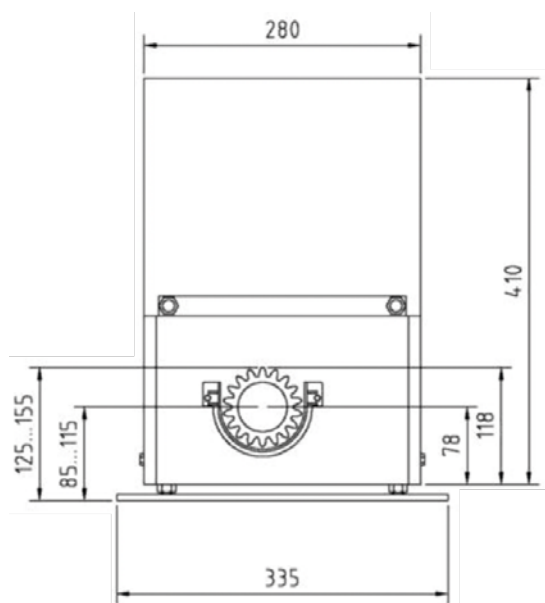

View from the side:

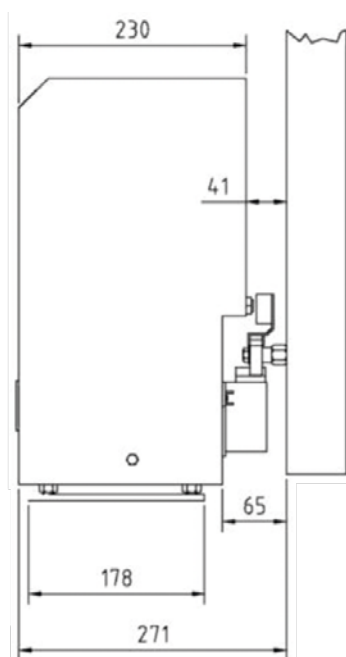

View from the bottom:

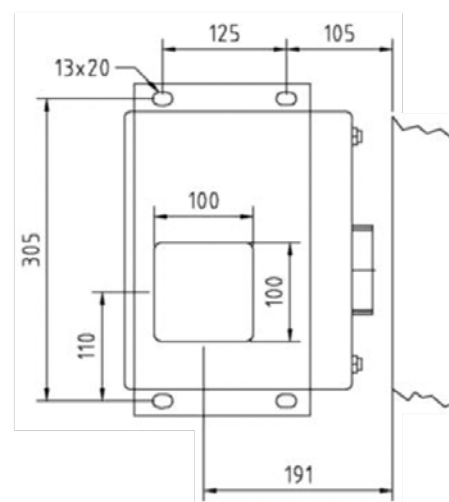

Technical data 230V in a convenient housing

230V gate opener	EST 1204K	EST 2004K
Max. gate weight	1,200kg	2,000kg
Max. gate length	12,000mm	16,000mm
Power supply	230V / 50Hz	
Motor voltage	230Vac	
Velocity max.	0.18m/s	
Self blocking when gate OPEN/CLOSED	yes	
Max. cycles per hour	14	10
Brake function	yes	
Limit switches	2 magnetic	
Maintenance power outlet	yes	
Emergency release	yes	
Height adjustable	30mm	
Toothed wheel	Module 4, zinc coated (optionally module 6)	
Dimensions (WxHxL)	372x800x270mm	
Weight approx.	37.5kg	38.0kg
Controller	MO 44-2	

View from the front:

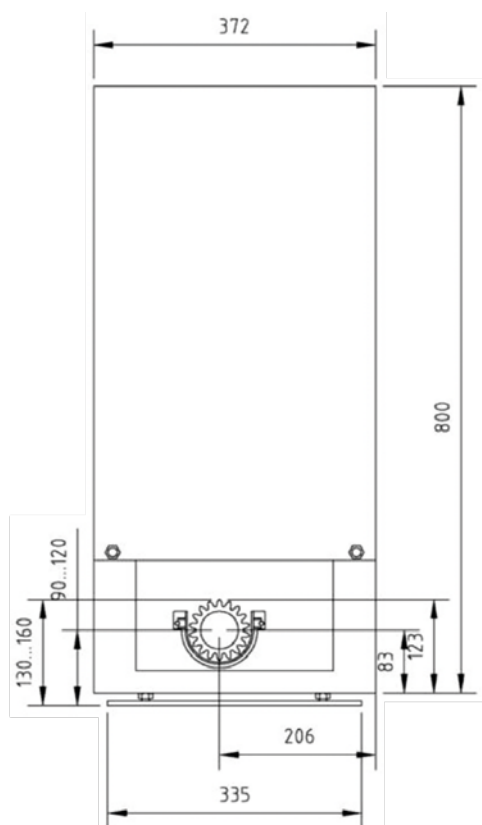

View from the side:

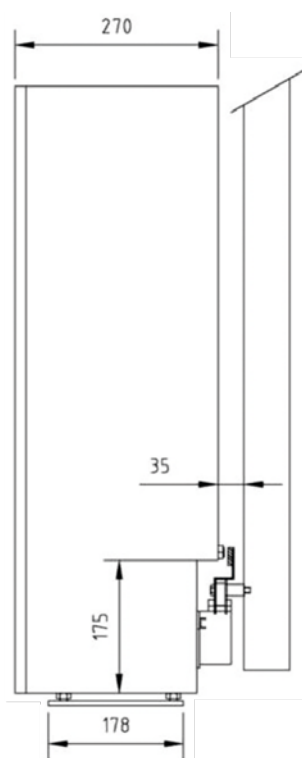

View from the bottom:

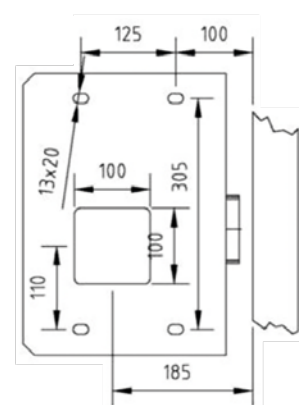

Technical data 400V in a convenient housing

230V gate opener	EST 2204K	EST 4004K
Max. gate weight	2,200kg	4,000kg
Max. gate length	18,000mm	20,000mm
Power supply	400V / 50Hz	
Motor voltage	400Vac	
Velocity max.	0.18m/s	
Self blocking when gate OPEN/CLOSED	yes	
Max. cycles per hour	9	8
Brake function	yes	
Limit switches	2 magnetic	
Maintenance power outlet	yes	
Emergency release	yes	
Height adjustable	30mm	
Toothed wheel	Module 4, zinc coated (optionally module 6)	Module 6, zinc coated
Dimensions (WxHxL)	450x800x270mm	
Weight approx.	41.0kg	88.0kg
Controller	MO 44-2	

View from the bottom:

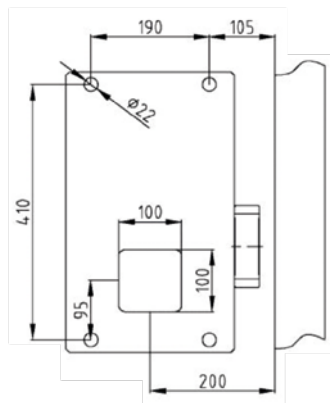

View from the side:

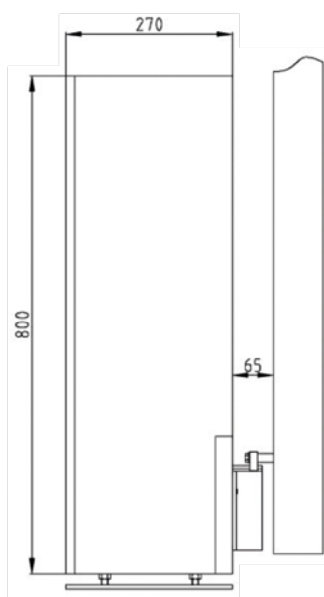

View from the front:

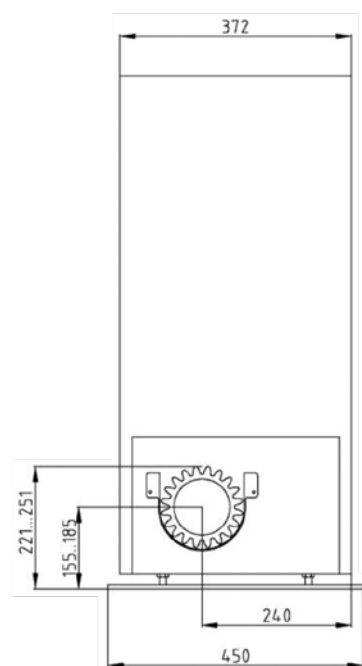

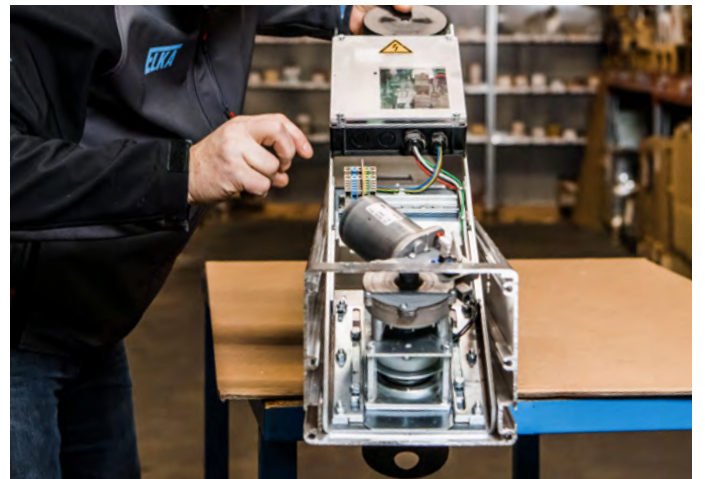

ELKA TORANTRIEBE

Partner with competence



ELKA is a German manufacturer of gate openers and barrier systems of high quality with an experience of more than 40 years. We place a great value on high quality components, easy installation and customerfriendly service. „Partner with competence“- the management as well as the employees feel committed to this philosophy. ELKA stands for individual customer service. Fast order processing, short delivery times and adherence to deadlines are a matter of course for us. Our technicians at the service telephone know all products in detail and assist you during the planning of your projects. We are looking forward to your enquiries.

- ✓ Competent support
- ✓ Short delivery times and adherence to delivery dates
- ✓ Quality „Made in Germany“





We develop products for our customers. We have the highest demands on quality, functionality and comfort. Early in the development phase, suppliers, production department and customers are involved in the development process. All ELKA products are constantly supervised by the product development department and are continuously developed and improved – also after product market launch.

✓ In-house product development

✓ Support beyond development

✓ TÜV-tested products



Quality to the last detail



We meet our high quality standards through the use of high-quality materials and coordinated components. All goods received are controlled at delivery on quality and technical specifications and are tested by using a 3D coordinate measuring machine. This enables us to guarantee precisely fitting components and an optimal installation process. Our production processes are regularly monitored. It goes without saying that every product is subjected to a comprehensive final inspection and functional tests before delivery.

- ✓ Precisely incoming goods inspection
- ✓ Supervised processes
- ✓ Final inspections and functional tests

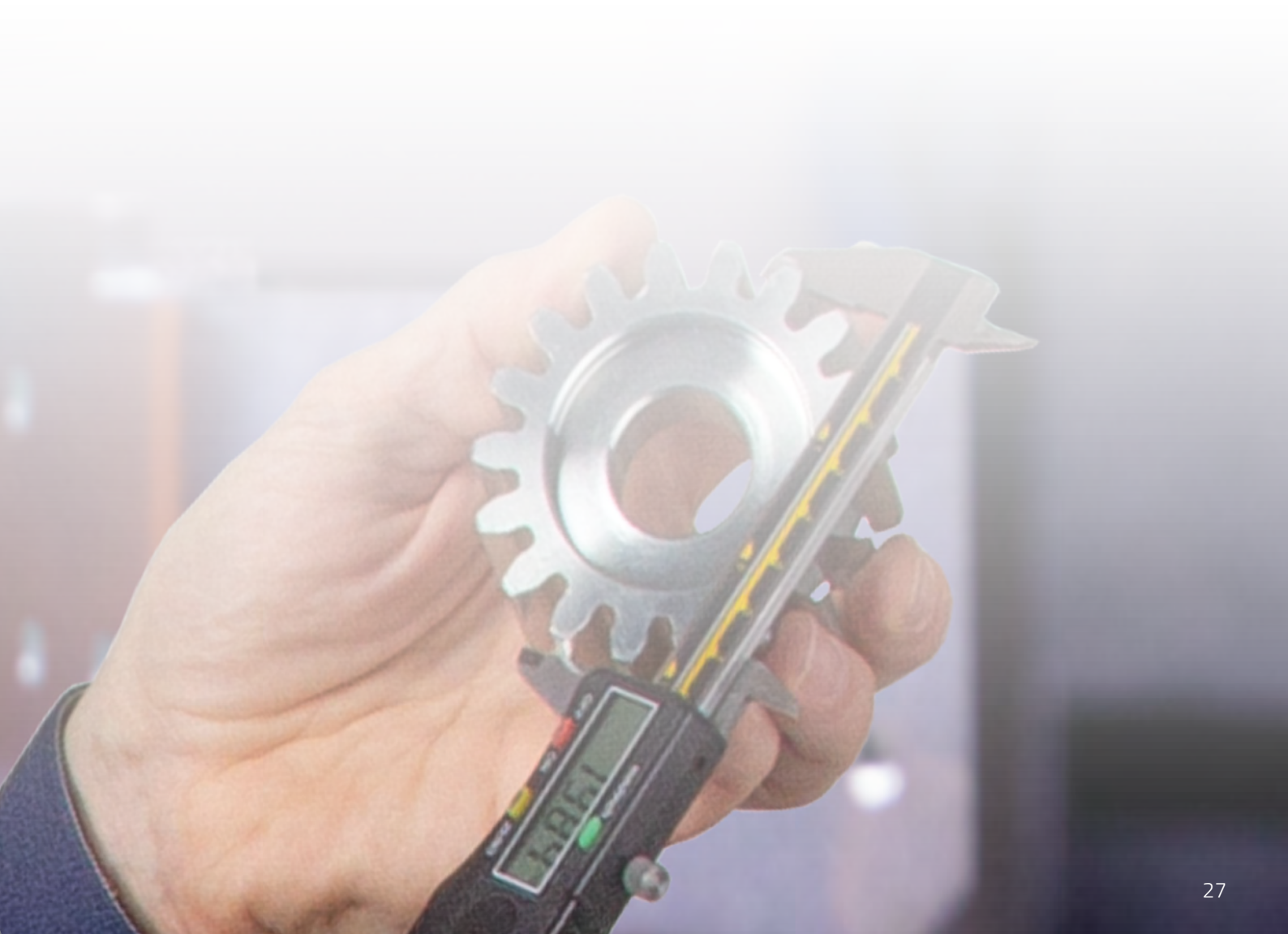

Individual support



ELKA delivers products worldwide to more than 80 countries and supports the customers in three languages. Technically trained specialists and engineers respond individually to customer needs. For more than 40 years ELKA stands for a professional order processing, short delivery times and adherence to delivery times – benefit from our experience and take part in one of our technical training courses. Visit us at our factory in Tönning or at one of the trade fairs worldwide where ELKA exhibits.

Further information can be found on our website: www.elka.eu

✓ Personal customer service

✓ Professional order processing

✓ Individual shipping organization





ELKA-Torantriebe GmbH u. Co. Betriebs KG

Dithmarscher Str. 9, 25832 Tönning / Germany

 **info@elka.eu**

 **+49(0)4861-9690-0**

 **www.elka.eu**

 **+49(0)4861-9690-90**